

CRYOSTAT CROSS SECTION

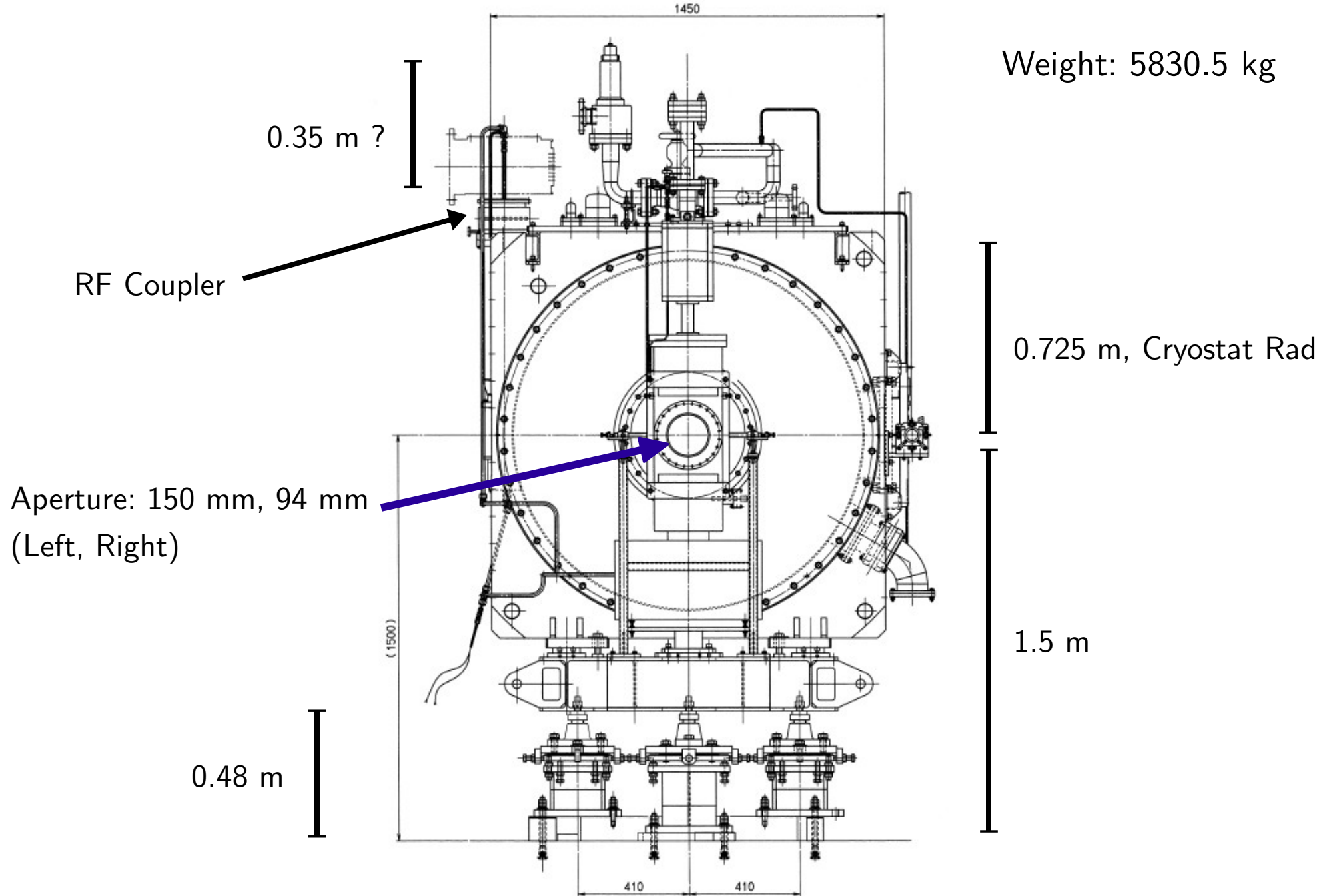

CRYOSTAT TOP VIEW

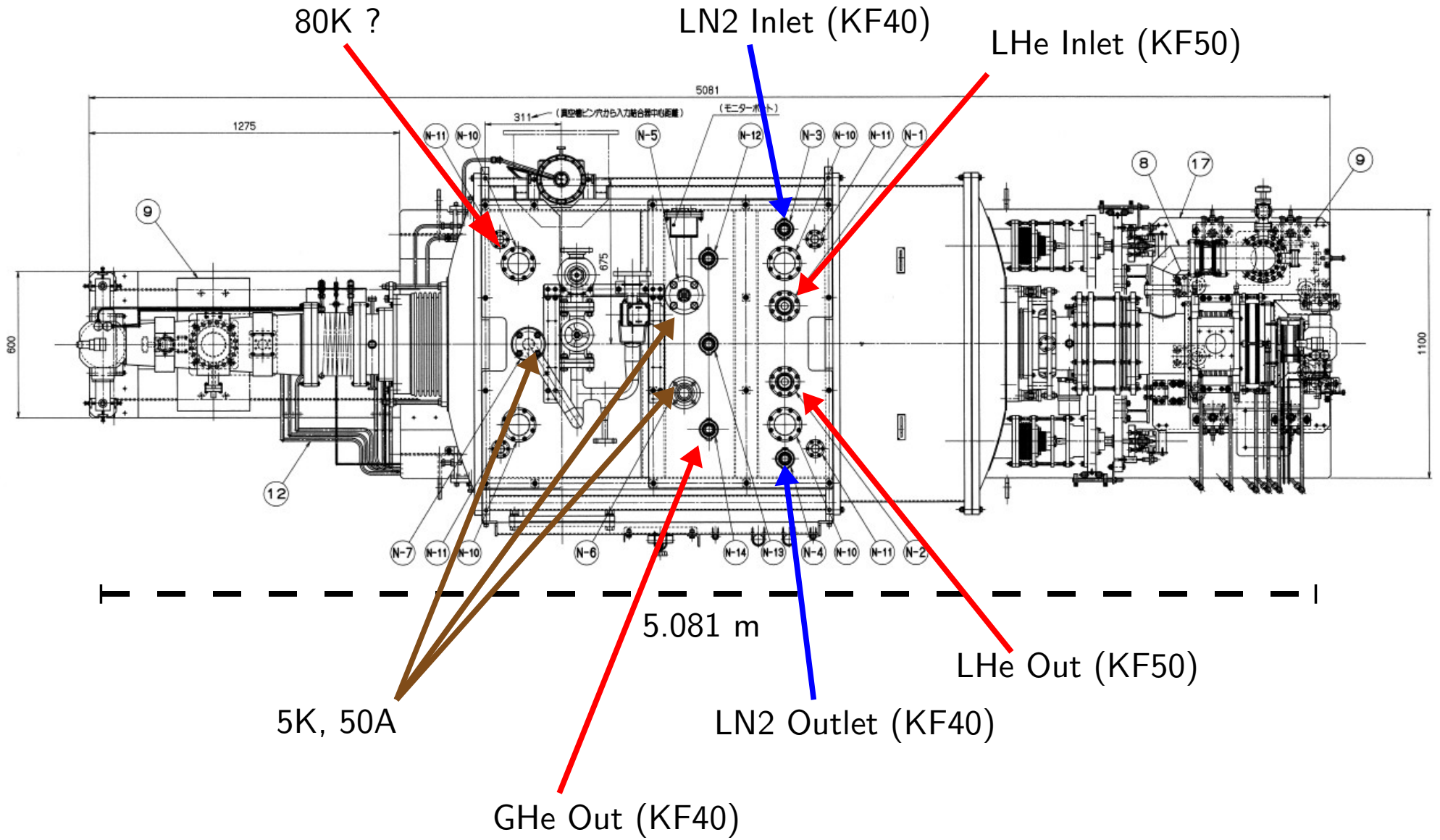

PRELIM RF & CRYO SPECS

Heat load

Static: 15 W (He), 110 W (LN2)

Dynamic: 50 W (He) corresponds to 1.5 MV kick

Volume of the Helium vessel: 400 L

Both liquid and gas volumes are connected

Cryogenic interfaces (Byonet drawings on web - .igs, .dwg)

Frequency tuning

Static: 2 MHz possible for SPS 100ns bunch spacing

Dynamic: 1 kHz/s, maximum range: 200 kHz (operations – 100 kHz)

RF power (Cavity $Q_0 > 1e9$)

Presently using: $1.3-2 \times 10^5$ (55-120 kW)

Alt Available: $1-1.3 \times 10^6$ (20 kW)

Feedback

Orbit feedback (slow, 1 sec)

COLDEX LOCATION, OPTICS

Longitudinal Position: 4020 m +/- 5m

Total length (in MAD): 10.72 m

β_x, β_y : 41.559m, 58.604m

μ_x, μ_y : 15.19652, 15.188

D_x : -0.58 m

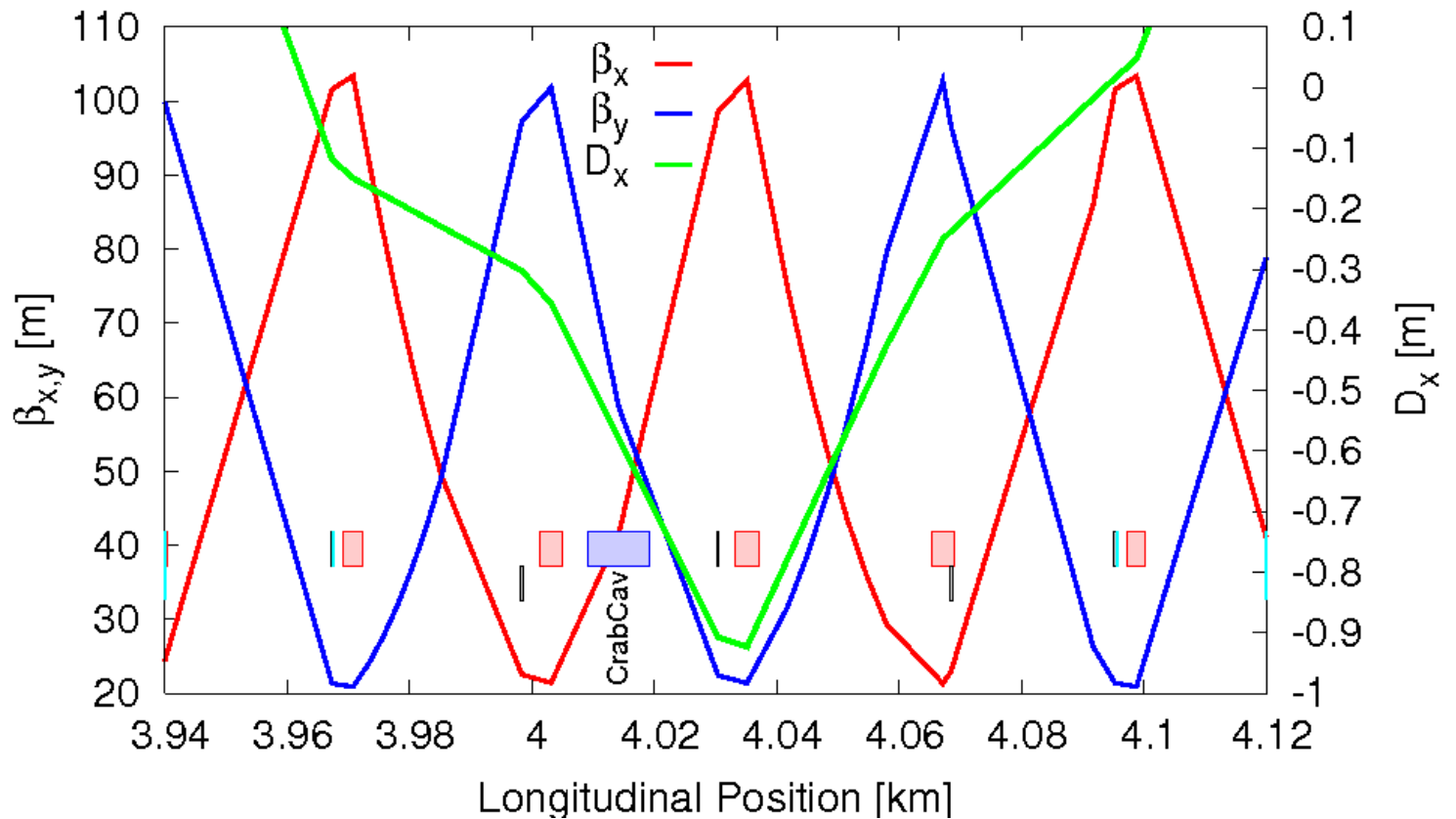

COLDEX LOCATION, MADX

$$V_{crab} = \frac{cE_0 \tan(\theta/2)}{\omega \sqrt{\beta_{cc} \beta(s)}}$$

Assuming $\pi/2$ phase advance between the CC & Observation point

$\beta_x = 41.559$ m, $\beta(s) = 100$ m, Freq = 510 MHz, E=120 GeV

Assuming 1.5 MV: $\theta/2 = 8.6$ mrad ($\lambda_{rf} \gg \sigma_z$)

Orbit excursion ($\sigma_z = 7.5, 15.0, 22.5$ cm) = 0.6, 1.3 1.9 mm

COLDEX LOCATION, MADX

Crab Voltage = 1.5 MV ($E_b = 120$ GeV)

$\theta/2 \sim ?$ mrad, $1\sigma_z = 7.5$ cm

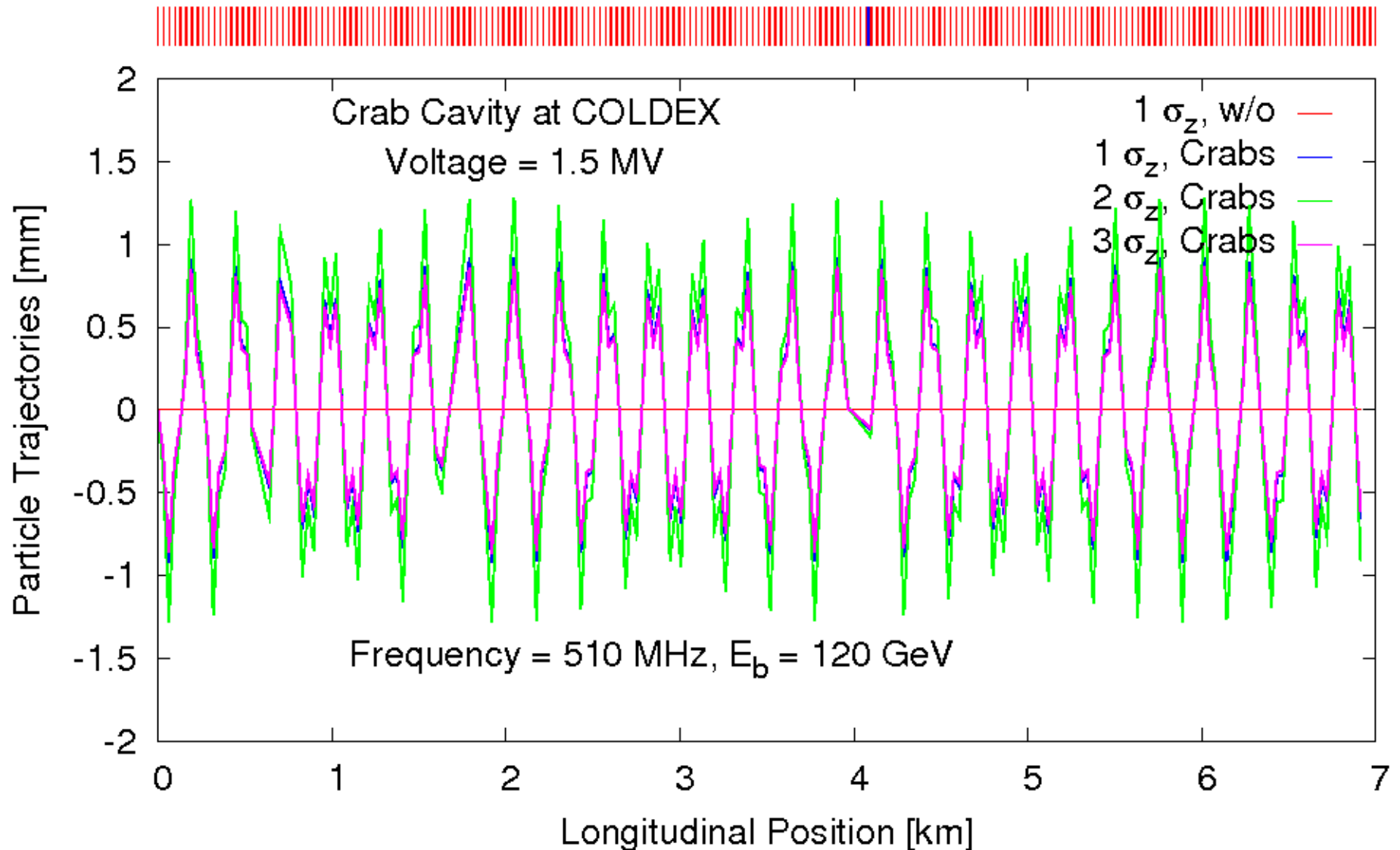

MORE ITEMS

Impedance spectra (Morita-san calculating)

Detailed beam dynamics (perhaps for after)

RF-loops (waiting for Akai-san)

Autocad-CATIA files for the cryostat (not available)

LER -or- HER cavity (should we pick high voltage -or- low trip rate)

Dog-leg -or- movable -or- install/uninstall ?

Approximate schedule

KEK-B runs till June 2010, earliest availability ~summer 2011

LHC compact cavities ~ summer 2013 (assuming 2 yr construction, \$\$)

BEAM STEP I: COMMISSIONING

Feasibility of crab cavities in a hadron machine (circulate & beam survival)

Injection (26 GeV), Ramp (26-120 GeV), Coast (120 GeV, 270 GeV)

1-12 bunches, $3-5 \times 10^{10}$ /bunch

ϵ_n : 3.75 μm , Tunes: 26.125, 26.18

Cavity performance

Static & dynamic frequency tuning (510-511 MHz)

Phase tuning (zero crossing from minimum orbit)

Cavity ramping (0-1.5 MV)

Reliability & trip rate (with & w/o beam)

Machine protection, interlocks and worst case scenarios

example: one turn failure (voltage or phase)

Long term orbit, tune stability

INSTRUMENTATION & SPECS

SPS BPMs (single plane, 100?)

Closed orbit +/- 3 mm, resolution ~ ? microns

LHC BPMs (double plane, 4? possibly more):

Resolution < 0.3 microns (closed orbit, turn-by-turn)

Bunch-to-bunch variations (for example 50 ns spacing)

Tune Measurement (Qmeter, BBQ): 10^{-3} , 10^{-4}

Emittance (scanners, BTVs):

Measure 1% emittance growth/hr (induced noise maybe produce more)

Headtail monitor, Wide band pickup

Intra-bunch characteristics

BCT, Fast-BCT

eCloud monitor (some effect was proposed by L. Wang a while ago)

KEK-B EXPERIMENTS, ELECTRONS

What has been done

Noise studies and emittance growth → RF phase noise specifications

Instability driven by beam-beam between sigma-pi mode

Crab dispersion measurements

Future experiments

Accumulation of beam with crab-on

Crab cavity ramping and effect on the beams

Detailed study of RF parameters due to a trip

Beam survival after RF trip (currently aborted for safety)

KEK-B EXPERIMENTS, RF NOISE

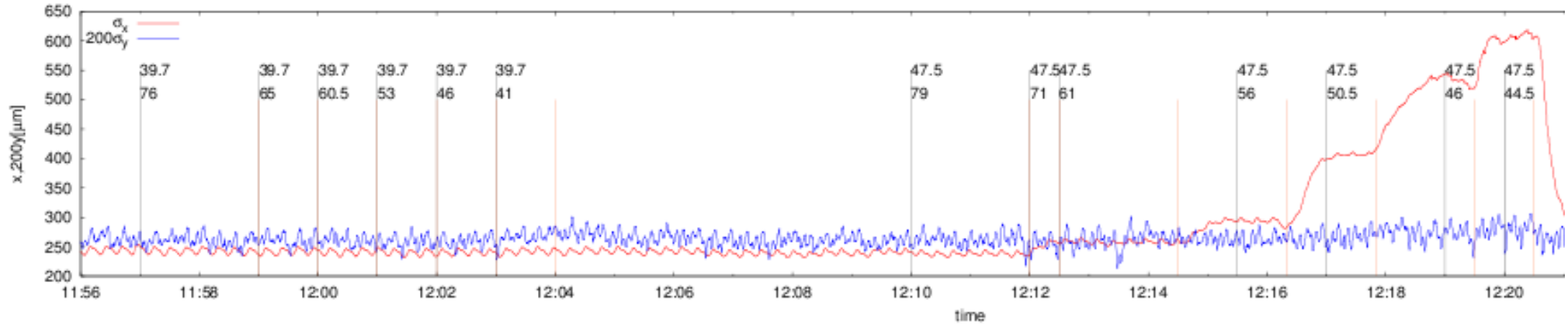

Systematic noise experiments performed at KEK-B with & w/o beam-beam

First effects of noise observed at 0.03 deg phase noise

Effect on emittance observed close to the betatron spectrum

Effect is observed at lower noise levels in the presence of beam-beam

KEK-B EXPERIMENTS, RF NOISE

Beam-beam driven Coherent peak observed between the sigma-pi mode
Leads to rapid emittance growth and luminosity degradation

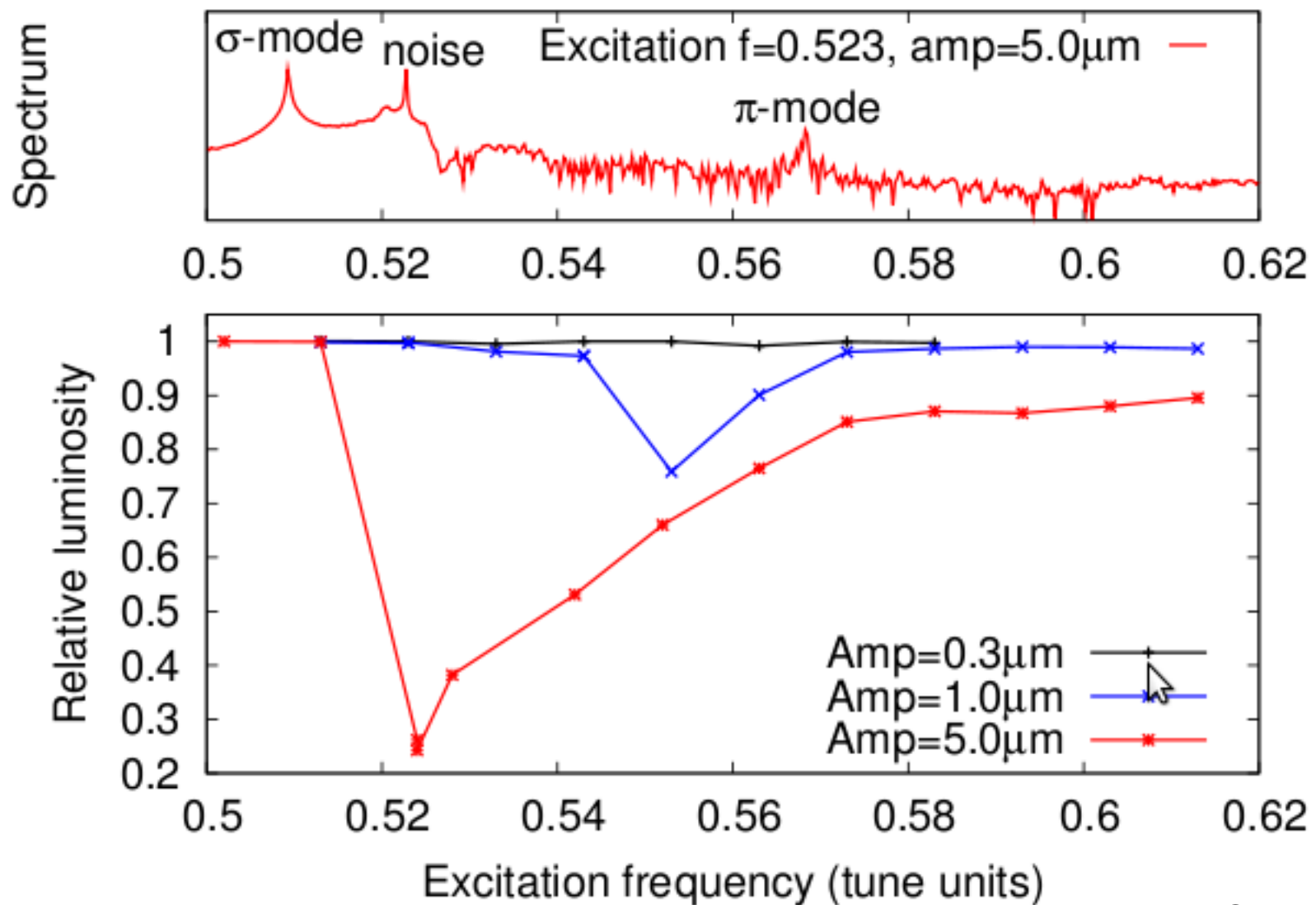

KEK-B EXPERIMENTS, CRAB DISPERSION

Very good agreement with the model

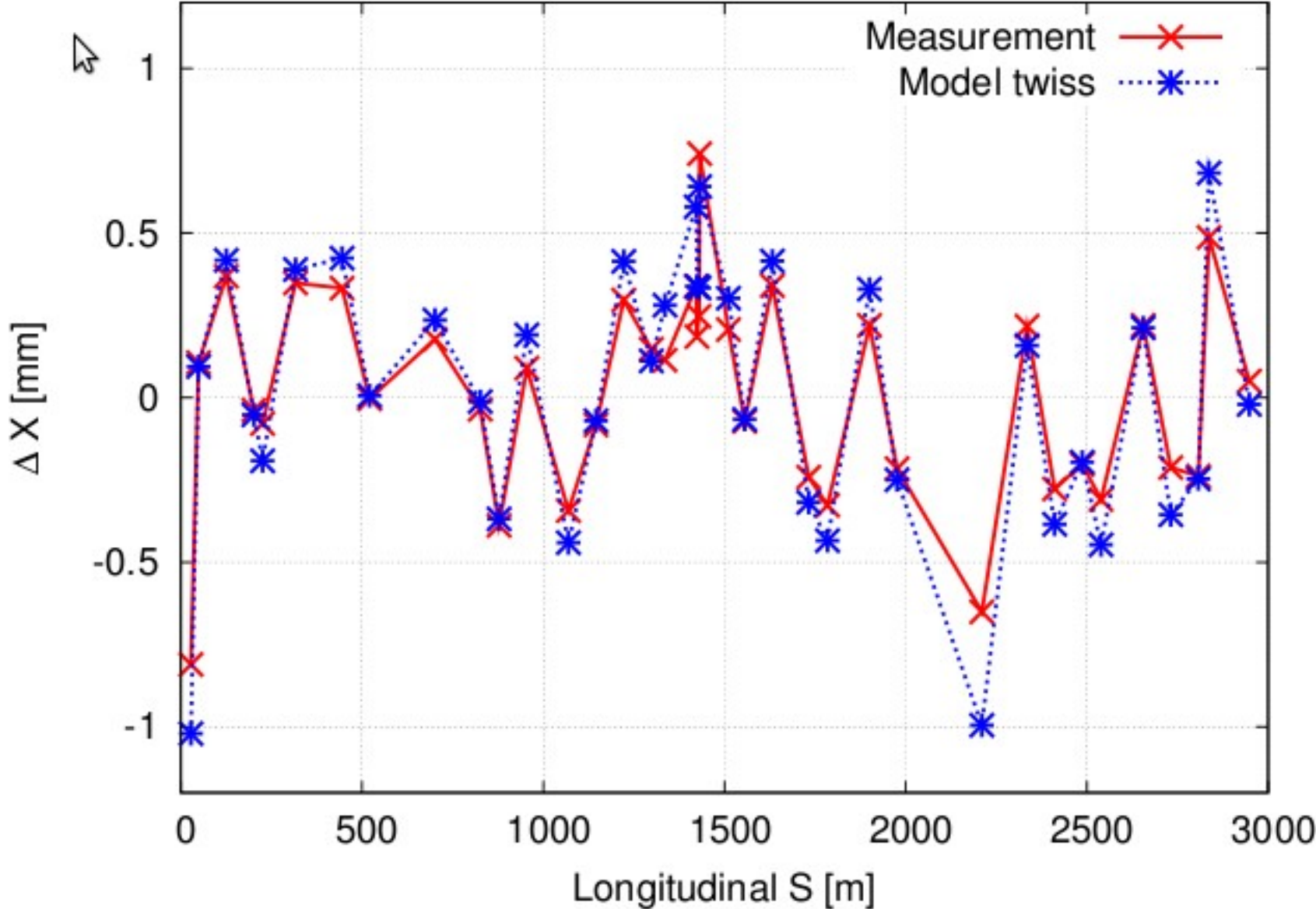

SPS TEST OBJECTIVES, PROTONS

Safe beam operation (low intensity) & reliability

Tests, measurements (orbits, tunes emittances, optics, noise)

Collimation, scrapers to reduction of physical aperture with & w/o crabs

DA measurements (possible ?)

Intensity dependent measurements (emittance blow-up, impedance)

Coherent tune shift and impedance

Instabilities

Beam-beam effects (BBLR – tune scan, current scan)

Other non-linearities (octupoles)

Operational scenarios

Accumulation of beam with crab-on & crab off

Beam loading with & w/o RF feedback & orbit control

RF trips and effects on the beam

Energy dependent effects

Long term effects with crab-on, coasting 120 GeV